



**TURAN<sup>®</sup>  
METAL**

**Koltuk Somyaları ve Mekanizmaları**

**SOFA BED MECHANISM**



• Sofa bed mechanisms •

# BİZ

İnegöl'de 5000 m2 kapalı alanda, teknolojik altyapımız ve uzman kadromuzla 1985' den beri koltuk mekanizmaları sektöründe hizmet vermekteyiz. Sürekli müşteri memnuniyetini hedef edinen anlayışla hareket etmekte buna bağlı olarak üretimde kaliteye özen göstermekteyiz. Sektörde ön sıralarda yer alan firmamız 50' nin üzerinde ürün çeşitliliğiyle koltuk üreticilerine çözüm ortağı olmayı kendine misyon edinmiştir.

Hızla değişen ihtiyaç ve beklentilere, aynı hızla araştıran, üreten teknik ekibimizle zaman kavramını ön planda tutarak cevap vermekteyiz. Ar-ge çalışmalarımızda sizlerden gelen talepleri, sektörü analiz ederek ve 30 yıla yaklaşan tecrübelerimizle harmanlayarak gerçekleştirmekte, yine sizin taleplerinin doğrultusunda ürün standardının dışına çıkıp firmalara özel Ar-ge ve üretim yapmaktayız. Turan Metal markasıyla satın aldığınız ürünler; kaliteli malzemeden üretilmiş ve elektrostatik fırın boya sistemimizde boyanmıştır. Yurtiçinde olduğu kadar yurtdışında da talep gören ürün portföyüne sahip firmamız, ülke ekonomisine de bu anlamda katma değer sağlamaktadır.

Yıllardır iç ve dış piyasada sağladığımız güvenle geldiğimiz yeri; teknolojik yenilikleri yakından inceleyerek, çalışanlarımızın sağlık ve güvenliğini önemseyerek kurduğumuz üretim sistemimiz, araştırma ve geliştirme odaklı kaliteli üretim sürecimiz, satış öncesi ve sonrasında müşteri odaklı iş anlayışımızla koruma ve müşterilerimizle birlikte büyüme çabamızdayız.

# WE

Turan Metal has been serving 5000 m2 closed area in inegol with technological infrastructure and professional staff in sofa bed mechanisms industry since 1985. Our company is aiming the continuous customer satisfaction and emphasis on quality production. Our company which is on a mission to become a solution partner with over 50 product types at the forefront of the industry.

Rapidly changing needs and expectations, same rapidly researching and producing technical team responds by giving priority to the time. For R & D demands of our work requests which come from you, analyzing industry and about 30 years of experience realizing and come out of the standart product, private producing and R & D. Purchase mechanisms which is brand of Turan Metal; made of high quality metarials and painted with electrostatic painting system. Demand in the country as well as abroad, our company which has a range of produsts, provides added value to the national economy in thid sense.

For many years, we provide confidently forward seat in domestic and international market; closely analyzing the technological innovations and taking into the health and safety of workers install production system, research and development-oriented quality production process, with before and after sales customer-oriented compassion business growth with our customers and strive to continue expanding.





# INDEX

## KOLTUK MEKANİZMALARI

S	SOMYA	6
IS	İSKELET	34
MS	MOTORLU SOMYA	38
R	REFAKATÇI KOLTUK	45
B	BAZA	56

S-252

İNCİ İKİLİ MEKANİZMA

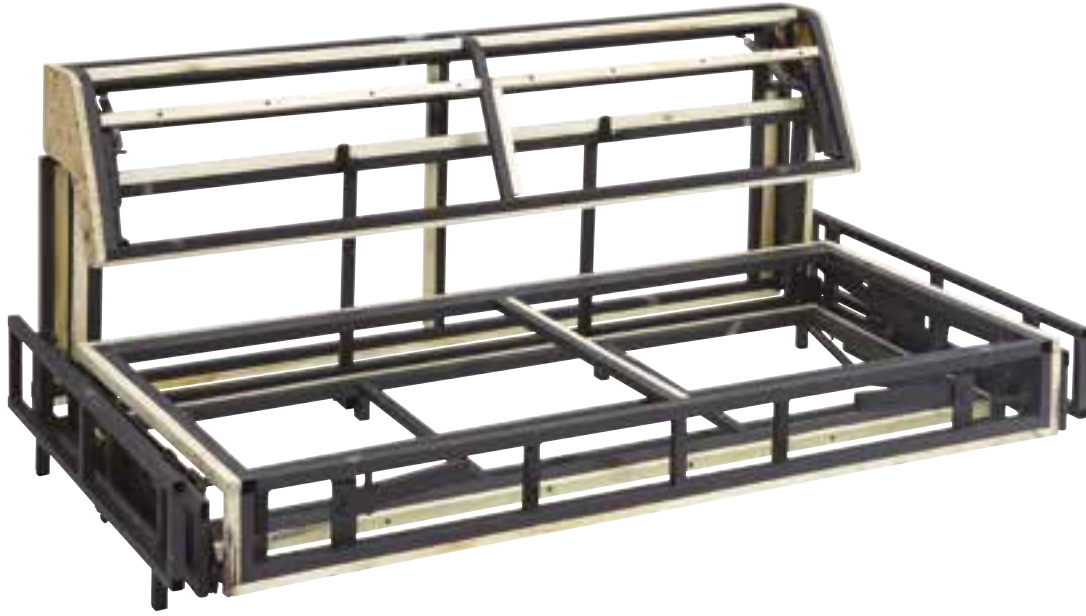

Bu Ürünümüz Patentlidir.





Bu Ürünümüz Patentlidir.



S-260

VENÜS ÇİFT OTURUM

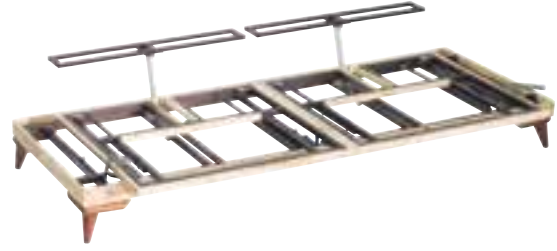

Bu Ürünümüz Patentlidir.









Bu Ürünümüz Patentlidir.





Bu Ürünümüz Patentlidir.

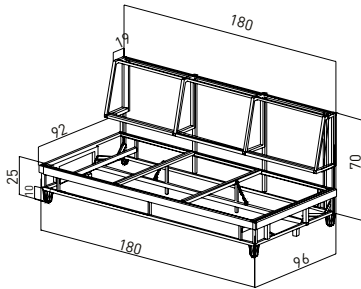

# S-206

## NEVA SANDIKLI SOMYA



Bu Ürünümüz Patentlidir.

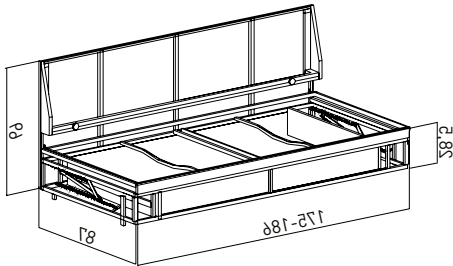



Bu Ürünümüz Patentlidir.

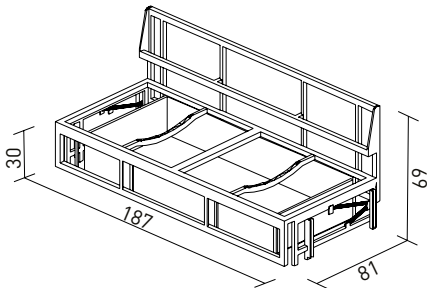

S-263

KOLLU FONT KAYDIRMA



Bu Ürünüñ Patentlidir.





Bu Ürünümüz Patentlidir.



2016-2017  
SOFA BED MECHANISMS

# S-243 A ÇİFT AÇILIR DİZAYN FOND KAYDIRMA



Bu Ürünümüz Patentlidir.







Bu Ürünümüz Patentlidir.





Bu Ürünümüz Patentlidir.

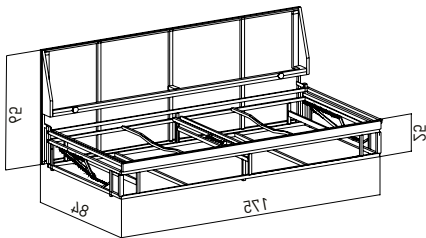



Bu Ürünümüz Patentlidir.

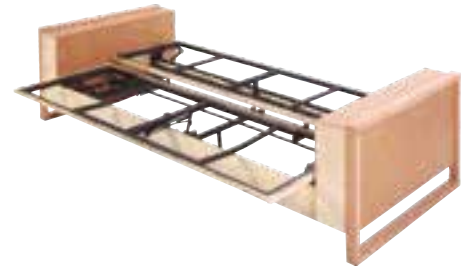
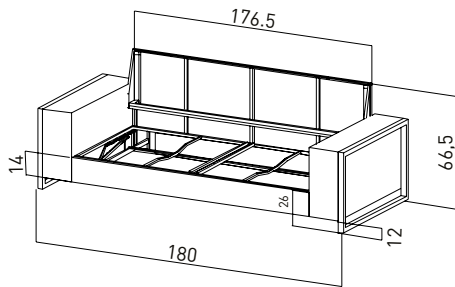

S-228

FERRARI YÜKSEK AYAKLI 17cm



Bu Ürünümüz Patentlidir.





Bu Ürünümüz Patentlidir.



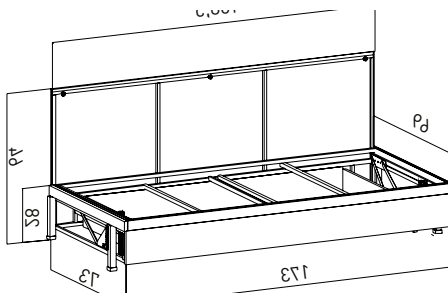



S-217

ASANSÖRLÜ AYAKLI SOMYA

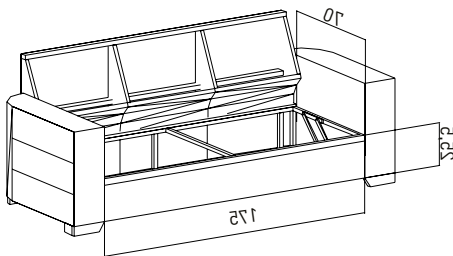



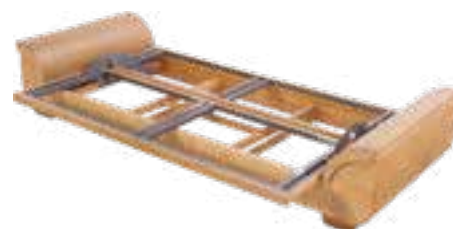
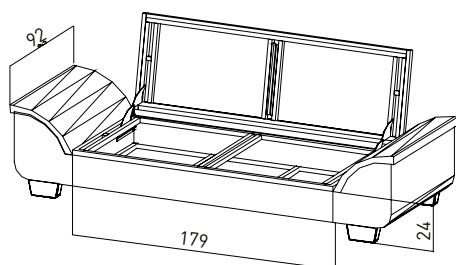

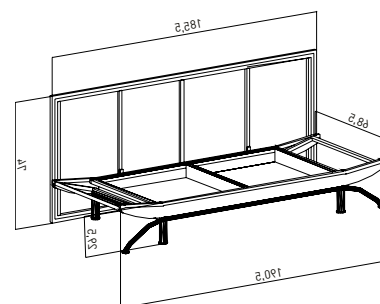

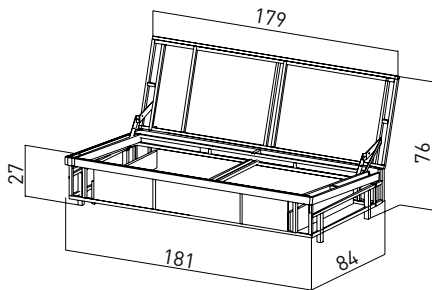

# S-230

## SEVDE ÜÇLÜ ve SEVDE İKİLİ SOMYA

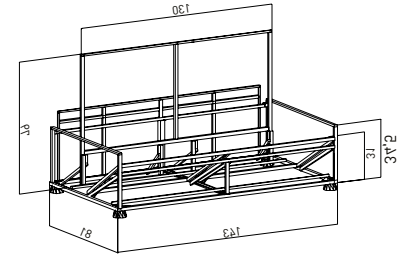
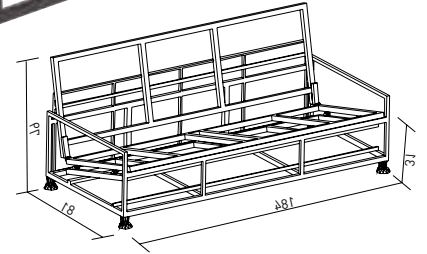

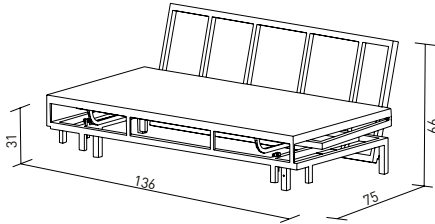
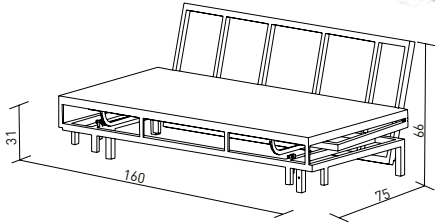

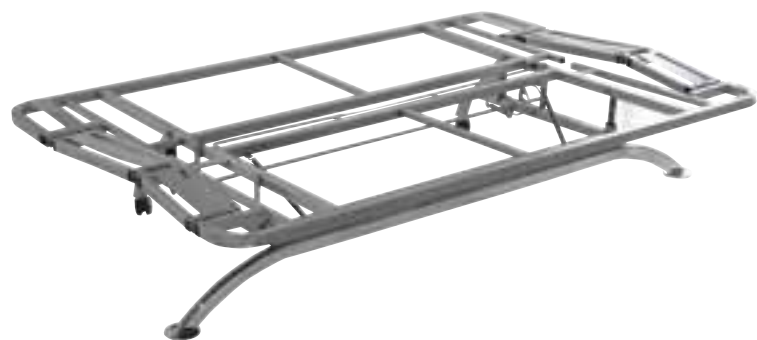

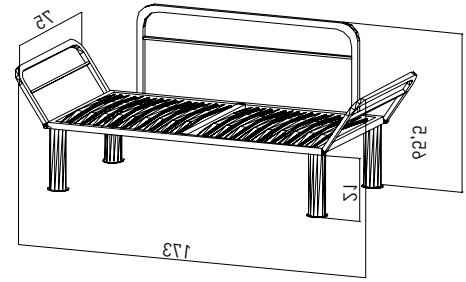

S-247

LATALI OTEL SOMYA







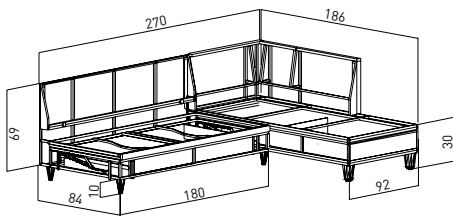

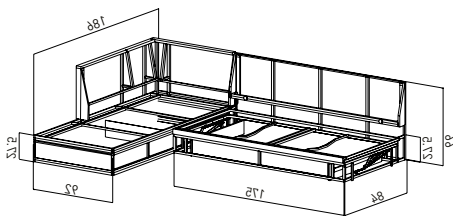





Bu Ürünümüz Patentlidir.





Bu Ürünümüz Patentlidir.





Bu Ürünümüz Patentlidir.



# MS-141 İNCİ MOTORLU



Bu Ürünümüz Patentlidir.







Bu Ürünümüz Patentlidir.

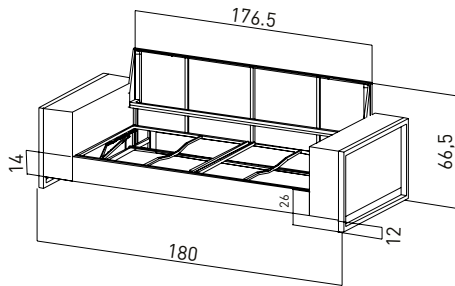

MS-111

TEK KİŞİLİK ÇERCEVE MOTORLU YATAK





Bu Ürünümüz Patentlidir.



# MS-150 TV KOLTUK MEKANİZMA



Bu Ürünümüz Patentlidir.





Bu Ürünümüz Patentlidir.





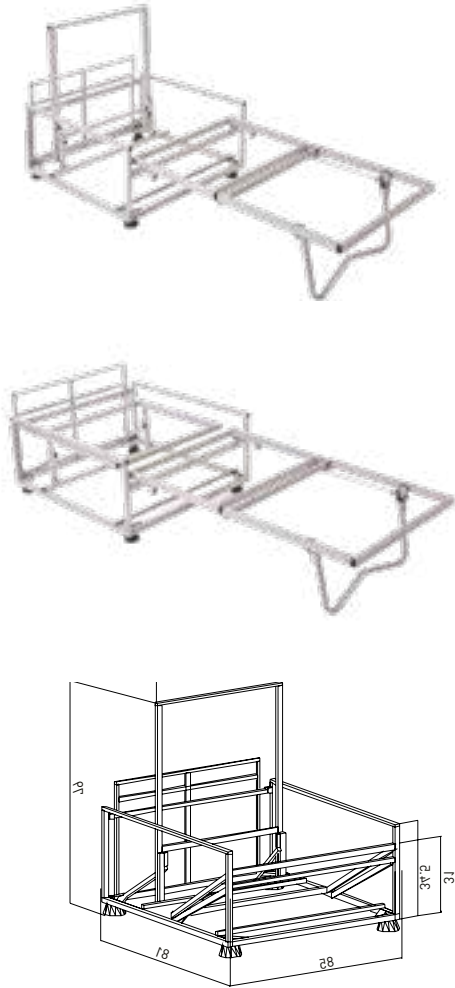



Bu Ürünümüz Patentlidir.







Bu Ürünümüz Patentlidir.







R-235

OSCAR TEKLİ







Bu Ürünümüz Patentlidir.









B-200

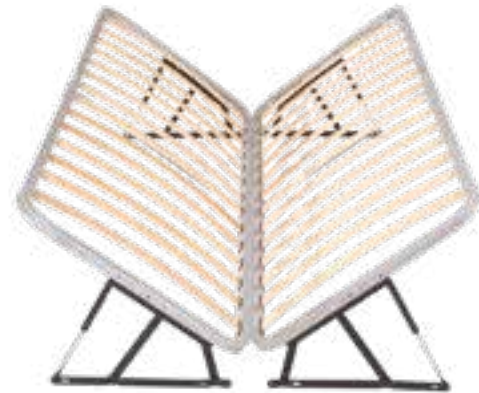
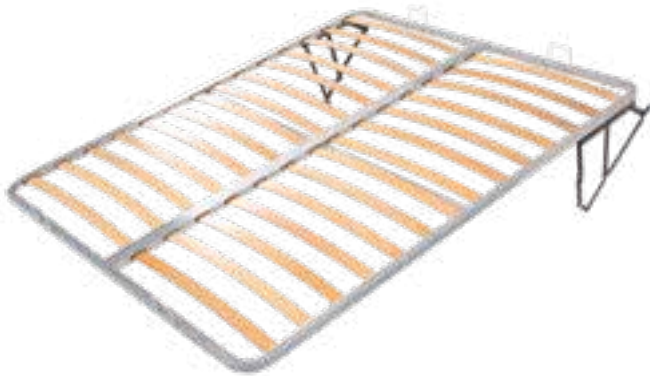

B-201



YS-02

YS-01



## B-101



## B-102



B-103



B-104





Mahmudiye Mh. Ağaçşleri Koop. 12.Mobilya Sk.  
No:39 İnegöl/Bursa/TÜRKİYE  
T: +90 224 718 52 86 / +90 224 715 55 51  
F: 90 224 718 52 47

info@turhanmetal.com.tr

[www.turhanmetal.com.tr](http://www.turhanmetal.com.tr)

